

Trimflex 277V 8 in. 3000K, 1875lm LED Downlight with Modular Trim – White

- Attractive modular recessed downlight with high quality interchangeable trim
- 120-277V input voltage
- Phase-cut dimming at 120V
- ETL Listed – no additional hardware or housing required for installation
- Ships with smooth white trim
- Additional trims available in a variety of colors*
- Round trims are made of sturdy spun aluminum
- Simple installation – trims and light modules are threaded for easy secure installation; replaces both recessed housing trim and bulb
- Highly-recessed light source minimizes glare
- 42W fluorescent replacement lamp
- 3000K - warm white
- Compatible with most commercial dimmers**
- IC-Rated – suitable for insulation contact on or around housing
- Compatible with Philips Bodine ELI-S-20 Emergency Lighting Inverter
- Reduces energy consumption by over 40% when compared to traditional fluorescent bulbs
- 50,000 hours design lifetime
- 5-year limited warranty

*Additional trims sold separately.

**Dimming range may vary based on dimmer used.



Specifications	
Model	D8-L1875-C30-V277-TR
Part Number	70159
Color Temperature	3000K
Lumen Output	1875lm
Wattage	25W
Power Factor	0.9
CRI	80
Efficacy	75lm/W
Beam Angle	90°
Dimmable	Yes
Wet Rated?	No
Voltage	120-277V
Operating Temperature	-20°C to 40°C
Weight	24.32 oz.
Dimensions	9.65 x 4.33 x 9.65 in
Design life	50,000 Hours
Warranty	5-Year Limited Warranty
Energy Star Product Listing	D8-L1875-C30-V277-TR

Certifications:



Trimflex 277V 8 in. 3000K, 1875lm LED Downlight with Modular Trim – White

Additional Images:

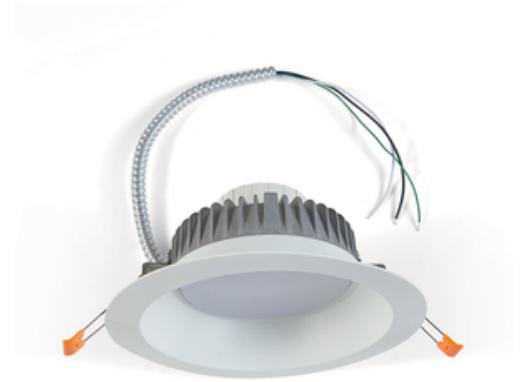

Diagrams:

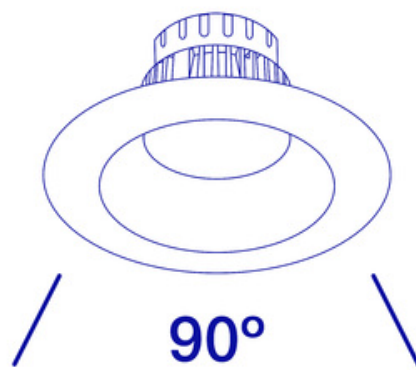
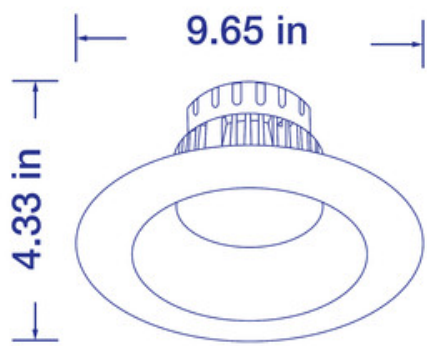

Available accessories:



8-inch Trim - Round, Black Smooth
(99546)



8" Goof Ring
(70459)

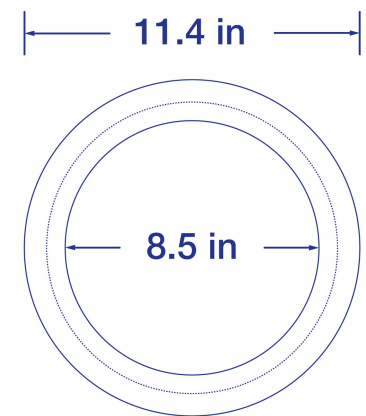

Dimensions
(70459)